

Foldaside projection butt hinges for frame to panel joints:

I Stainless steel projection hinge

102 x 102 mm. Thrust bearing washers to each joint

BS EN 1935 grade 13	Cat. No.
Satin stainless steel	921.08.168

Order qty: 1 pc

J Brass projection hinge

102 x 102 mm. Double phosphor bronze washers with brass pin

Finish	Cat. No.
Polished stainless steel	921.08.060

Order qty: 1 pc

Foldaside butt hinges for panel to panel joints:

K Stainless steel butt hinges

102 x 76 mm. Thrust bearing washers to each joint. Satin or polished stainless steel or electrophoretic brass-plated stainless steel

BS EN 1935 grade 13	Cat. No.
Satin stainless steel	921.08.140
Polished stainless steel	926.91.041
Brass-plated	921.08.159

Order qty: 1 pc

L Brass butt hinge

102 x 76 mm. Double phosphor bronze washers with brass pin

Max. adj. door weight	60 kg
Polished	921.08.042

Order qty: 1 pc

M Twin ball catch

To act as holdback catch on access door or to prevent door panel drift.. Tension adjustable with a screw-driver. Solid chrome steel balls. Brass catch and counterpiece

Finish	Cat. No.
Bright brass	244.20.017
Nickel-plated	244.20.639

Order qty: 1 pc

N Lever action flush bolt

For folding doors. Zinc die cast mazak alloy

Finish	Cat. No.
Pol. brass, lacquered	900.17.815
Satin nickel-plated	900.17.806

Order qty: 1 pc

O Lever action flush bolt

For folding doors. With adjustable shoot; 25, 30, 35 or 40 mm for added security. Brass

Finish	Cat. No.
Polished brass	900.17.860
Satin nickel	900.17.851

Order qty: 1 pc

P Flush handle

Fixing screws included. Brass

Finish	Cat. No.
Polished brass	910.37.035
Satin nickel plated	910.37.044

Order qty: 1 pc

2, 4, 6 or 8 leaves one way with swing leaf on opposite jamb

3, 5 or 7 leaves one or both ways

For ancillary door fittings, hinges and locks etc, see page 142

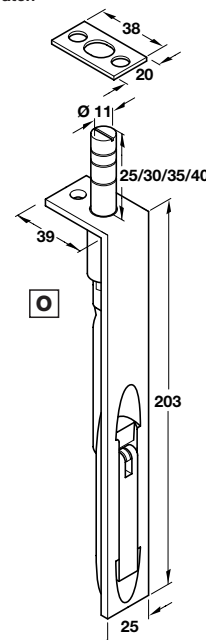
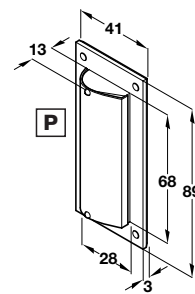
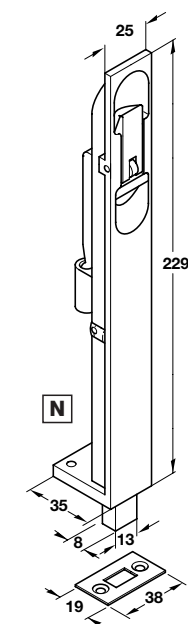
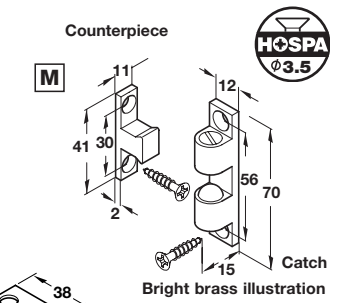
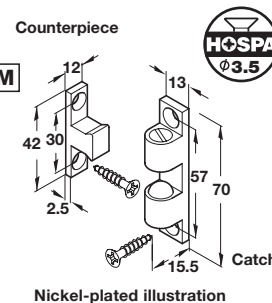
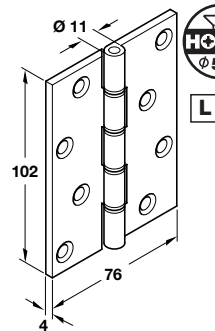
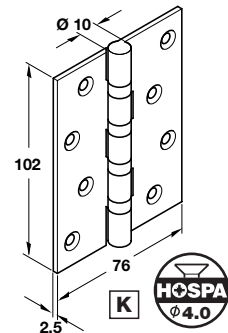
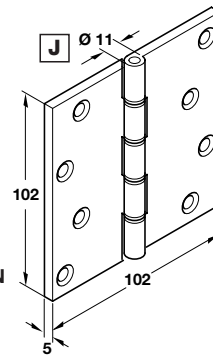
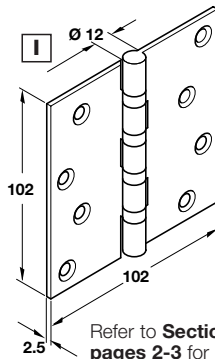

TCH-A1 2008, HUK. Dimensional data not binding. We reserve the right to alter specifications without notice.