

Fittings for Straight Sliding Timber Cabinet Doors

Rolluna Bottom Rolling

- Application:**
Multi-purpose robust bottom rolling system
- Range:** Max. door weight **55 kg**
Min. door thickness **19 mm**
Max. door height normally **2 m**
- Note:** For heavier bottom rolling sliding doors refer to Straightaway 700 bottom rolling system, shown in Section 11

For ancillary door hardware i.e. locks, handles and bolts etc. refer to page 19

Discontinued when stock=0
For 404.30.025 use alt. no. 402.23.803

A Top guide channel

Without screw-holes. Bright aluminium

Two upper guide channels are mounted side by side for double or multi-panel doors

Length	2.5 m	3.5 m
Cat. No.	404.30.019	+ 404.30.025

Order qty: Multiples of **2.5 or 3.5 metres**

B Top guide

With plastic roller and buffer pin to engage into stop
C. Galvanized steel

Cat. No.	● 404.32.900
----------	--------------

Order qty: 1 pair (order 1 pair per door)

C Clamp-stop

With screw for mounting in guide channel A. Black plastic

Cat. No.	404.32.004
----------	------------

Order qty: 1 pc (order 2 pcs per length of top guide channel)

D Anti-derailment device

For single panel sliding doors, screw-mounted.
Galvanized steel

Cat. No.	404.32.988
----------	------------

Order qty: 1 pc (order 1 pc per door)

E Follower/anti-derailment device

With rubber buffer, screw-mounted. For **three door layouts** when one of the doors should slide with the centre door. Also serves as an anti-derailment device. Galvanized steel

Cat. No.	404.32.997
----------	------------

Order qty: 1 pc (order 1 pc per pair of doors required to slide together)

F Bottom roller, edge fixing

With plastic-tyred, ball-bearing mounted roller, recessed and screw-mounted. Bright aluminium

Cat. No.	404.32.951
----------	------------

Order qty: 1 pc (order 2 pcs per door)

G Bottom track **Discontinued when stock=0**

For 404.31.016 use alt. no. 404.23.602

Press-fit type. Bright aluminium

Length	2.5 m	3.5 m
Cat. No.	+ 404.31.016	● 404.31.025

Order qty: Multiples of **2.5 or 3.5 metres**

Discontinued
For 404.31.025 offer alt. no. 402.23.603

Alternative bottom tracks:

H Bottom track, face fixing

Pre-drilled for countersunk screws. Galvanized steel

Length	3.0 m
Cat. No.	404.39.921

Order qty: 1 pc (3.0 m length)

I Bottom track, face fixing

Pre-drilled for countersunk screws. Stainless steel

Length	2.1 m	3.0 m
Cat. No.	941.80.621	941.80.630

Order qty: 1 pc (2.1 or 3.0 m length)

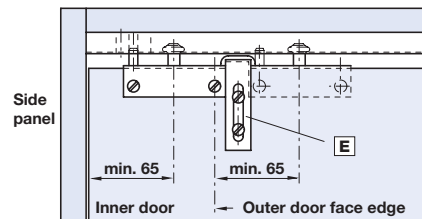
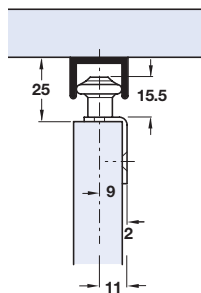
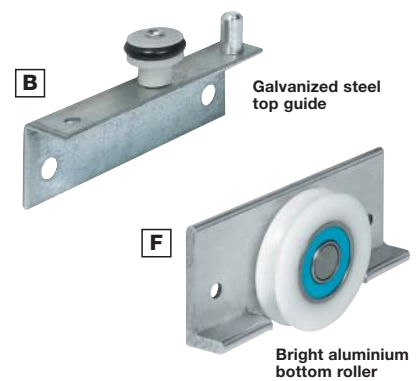
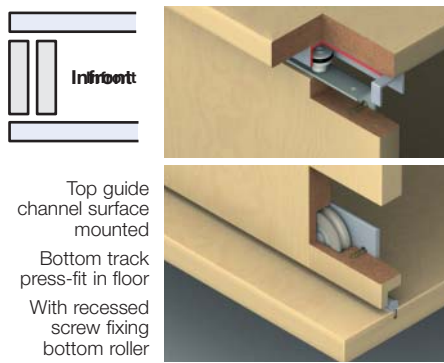

Please note:
Channel A and track G are priced and sold in metres
Please order in multiples of metre quantity shown

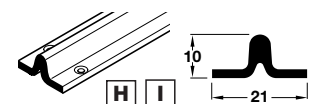
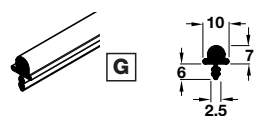
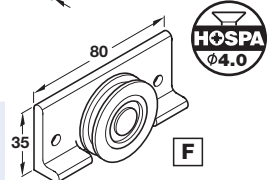
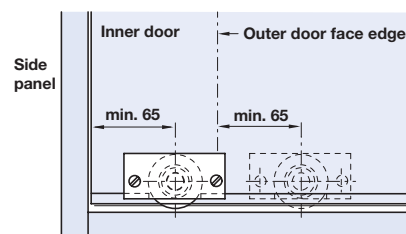
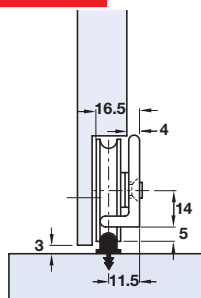
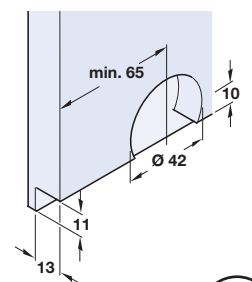
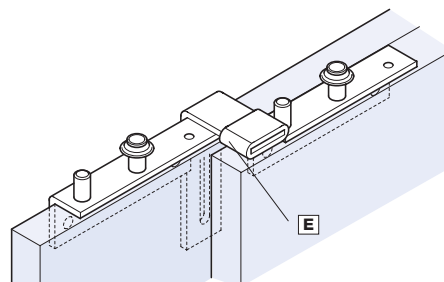
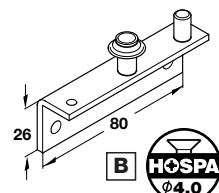
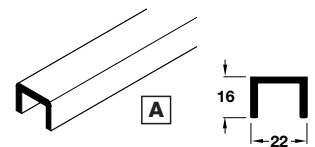
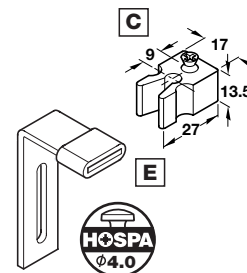
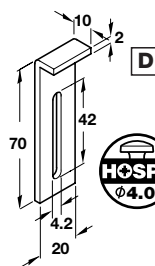

Discontinued ●
Discontinued when stock = 0 +